



HOLLER |||||

HOLLER ||||| ^{DIY}

DIY - Vrata i ograde

Vrata i ograde od čeličnog lima

Verzija 2024 (1. izdaja)

Zašto HOLLER DIY?

Naša inovativna rješenja uvjerit će vas dugim vijekom trajanja i lijepim izgledom. Vrata i ograde HOLLER DIY jednostavno se održavaju, a zbog posebne površinske obrade u našoj vlastitoj lakirnici dugoročno su otporne na vremenske utjecaje.

Naše prednosti

- klizna vrata imaju električni pogon sakriven u nosivom stupu i nije vidljiv - ljepši izgled i veća zaštita od prljavštine i vandalizma
- zupčasta letva kliznih vrata elegantno je sakrivena ispod aluminijskog profila
- okviri svih vrata izrađeni su od aluminija i nikada neće zahrđati
- aluminijska vrata triput se lakša od željeznih, što znači manje opterećenje za duži vijek trajanja
- električnog pogona
- odaberite ispunu od nehrđajućeg aluminija ili klasičnog lima, a mi ćemo je u vlastitoj lakirnici obojati postupkom praškastog bojanja
- kvalitetna izrada - sve je izrađeno u Austriji
- sigurnost ljudi je na prvom mjestu - sva vrata usklađena su s europskim standardom CE EN 13241-1 (zaštićena zupčasta letva i ugrađen pogon smanjuju mogućnost priklještenja prstiju, pogon automatski zaustavlja vrata udarom o prepreku, lakše pomicanje aluminijskih vrata u slučaju nestanka električne energije zbog iznimne lakoće)



**Klizna vrata
Krilna vrata
Osobni prolazi
Ograde**



Odaberite među dostupnim bojama:

7160 antracit mat

9006 srebrna

6005 mah zelena mat



SAMONOSIVA KLIZNA VRATA

Temeljni stup s ugrađenim pogonom H60



- Pogon ugrađen u stup i zupčasta letva sakrivena ispod bočnog profila - ljepši izgled
- Okvir i vodilica izrađeni su od visokokvalitetnih aluminijskih profila
- Kotači s ležajevima omogućuju gotovo nečujno pomicanje vrata
- Potporni valjci na gornjem dijelu okvira kreću se duž posebnog aluminijskog profila i ne oštećuju boju na vratima
- Masivni temeljni i prihvatni stup od aluminijskog profila dimenzija 150 x 150 mm

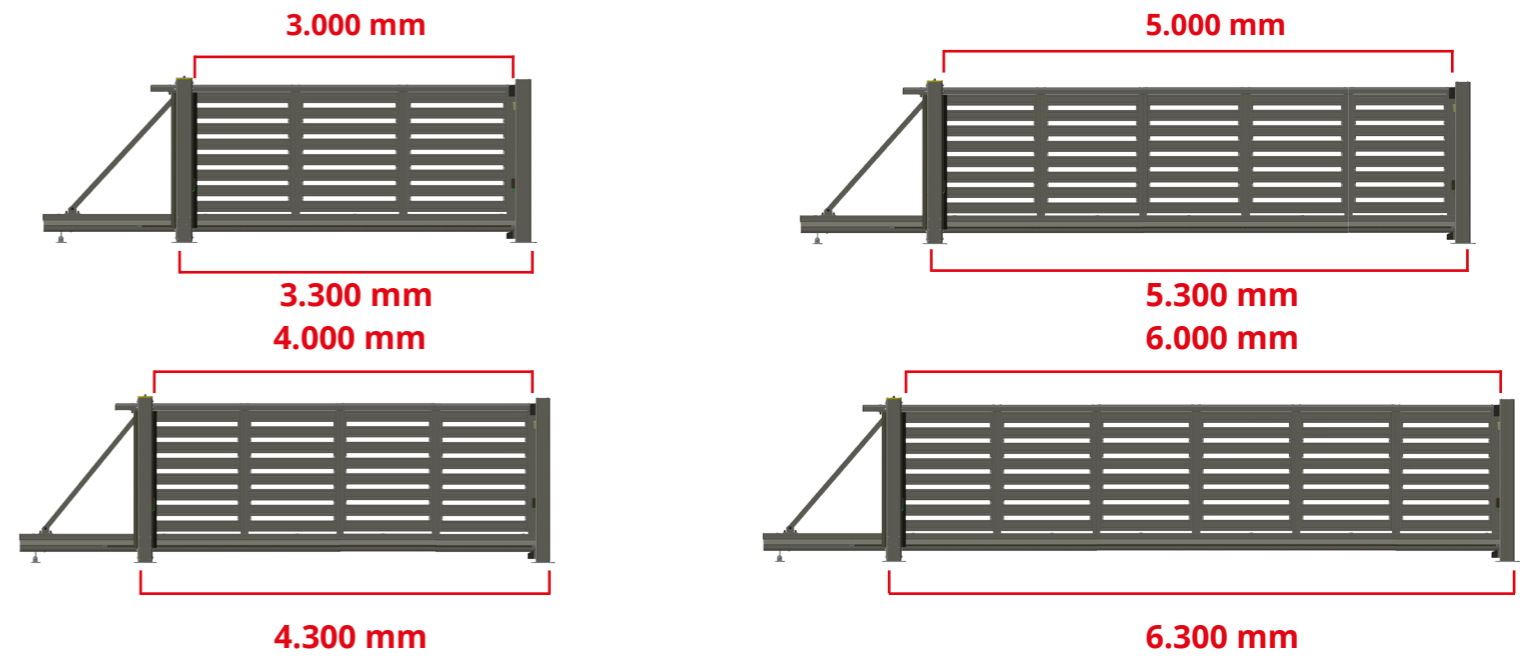

Ručno upravljanje:

- Masivna ključanica s 3 ključa
- Elegantna crna ručka

Automatsko upravljanje:

- Pogon i upravljanje ugrađeni su na nosivi stup.
- Fotostanica i treptajuće svjetlo za sigurnost
- Daljinski upravljač uključen (1x)

Visine:

- 1.000 mm
- 1.200 mm
- 1.400 mm
- 1.600 mm
- 1.800 mm
- 2.000 mm

uračunato je 100 mm razmaka od tla

Ispuna - lim



LIM GB
Valoviti lim

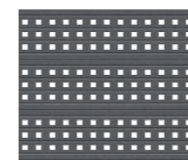

PERFORIRANI LIM LB
Valoviti lim s kvadratnom perforacijom 20 mm

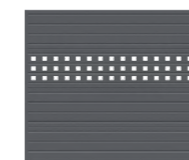

LIM S PERFORIRANOM TRAKOM GB+LB
Valoviti lim s trakom kvadratne perforacije 20 mm



POPREČNE GREDE Q100
100 mm



POPREČNE GREDE Q150
150 mm



POPREČNE GREDE Q200
200 mm

Ispuna - aluminij



ALUMINIJSKE OKOMITE ŠIPKE ST32
32 mm



ALUMINIJSKE OKOMITE ŠIPKE ST65
65 mm



ALUMINIJSKE OKOMITE ŠIPKE ST110
110 mm

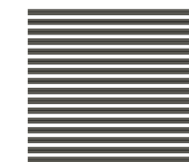

ALUMINIJSKE POPREČNE GREDE Q32
32 mm



ALUMINIJSKE POPREČNE GREDE Q65
65 mm

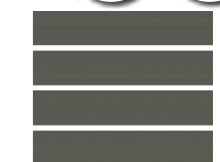

ALUMINIJSKE POPREČNE GREDE Q110
110 mm

KLIZNA VRATA - Ispuna od čeličnog lima

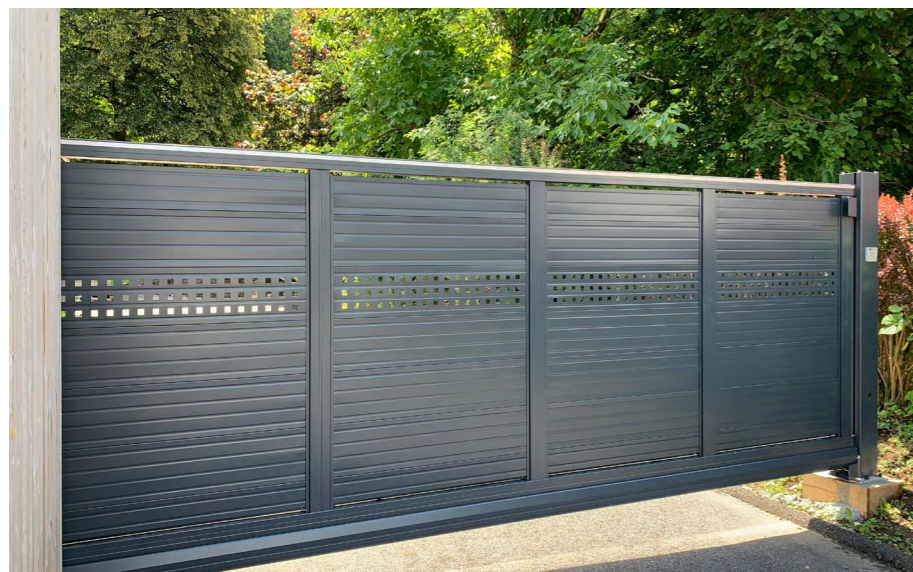

Klizna vrata
Glatki lim s perforiranom trakom, antracit boja



Klizna vrata
Glatki lim, zelena boja



Klizna vrata i ograda
Perforirani lim, srebrna boja



Klizna vrata
Poprečne grede 100 mm, antracit boja



Klizna vrata i ograda - dvobojna
Glatki lim s jednom perforiranom trakom, antracit i srebrna boja (posebna izvedba, upitajte kod prodavača)

KLIZNA VRATA - Ispuna od aluminija



Klizna vrata
Aluminijske okomite šipke 110 mm, srebrna boja



Klizna vrata
Aluminijske poprečne grede 65 mm, antracit boja



Klizna vrata
Aluminijske poprečne grede 32 mm, antracit boja

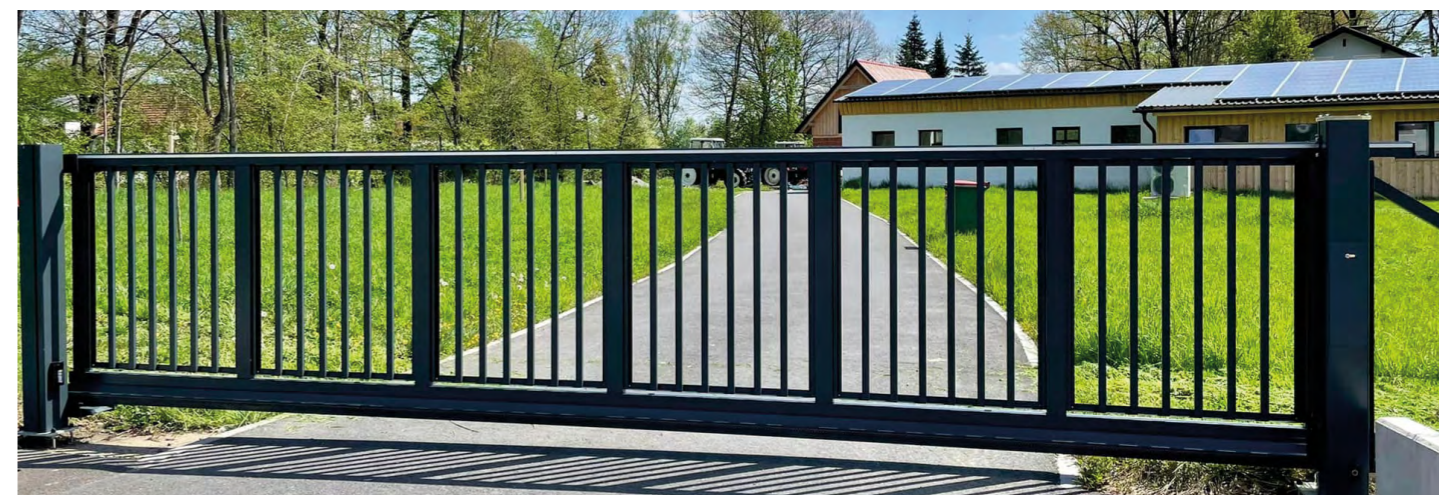

Klizna vrata
Aluminijske okomite šipke 32 mm, antracit boja



KRILNA VRATA

- Okvir od visokokvalitetnih aluminijskih profila
- Vrata se jednostavno prilagođavaju zahvaljujući podesivim šarkama.
- Masivni temeljni i ulazni stup od aluminijskog profila 150 x 150 mm



Pogon za krilna vrata

2-krilna vrata 1-1
Dva jednaka krila

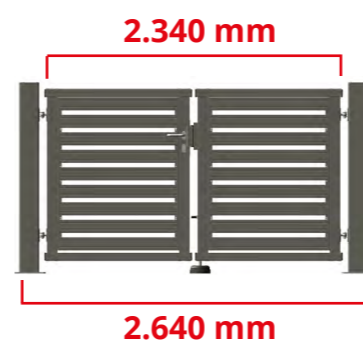

2-krilna vrata 1-2
Krila različite dimenzije

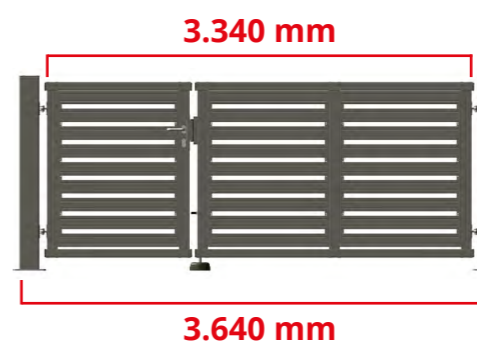

2-krilna vrata 2-2
Dva jednaka krila

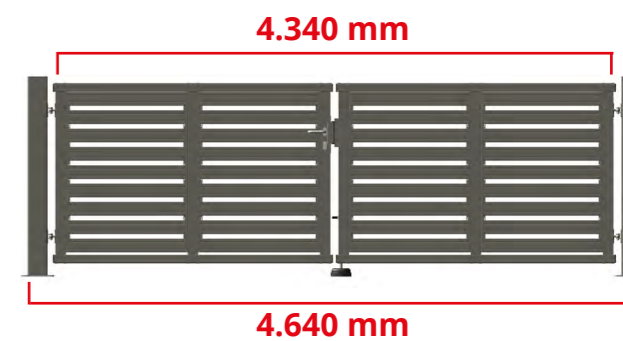

Ručno upravljanje:

- Masivna sigurnosna ključanica s 3 ključa
- Estetska crna ručka.

Automatsko upravljanje:

- Pogon i upravljanje ugrađeni su na nosivi stup.
- Fotostanice i sigurnosno treptajuće svjetlo
- Daljinski upravljač uključen (1x)

Visine:

- 1.000 mm
- 1.200 mm
- 1.400 mm
- 1.600 mm
- 1.800 mm
- 2.000 mm

uračunato je 100 mm razmaka od tla.

Ispuna - lim



LIM GB
Valoviti lim

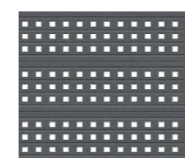

PERFORIRANI LIM LB
Valoviti lim s kvadratnom perforacijom 20 mm

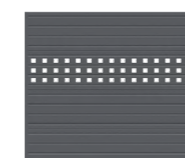

LIM S PERFORIRANOM TRAKOM GB+LB
Valoviti lim s trakom kvadratne perforacije 20 mm



POPREČNE GREDE Q100
100 mm



POPREČNE GREDE Q150
150 mm



POPREČNE GREDE Q200
200 mm

Ispuna - aluminij

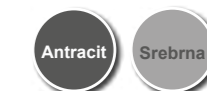

ALUMINIJSKE OKOMITE ŠIPKE ST32
32 mm



ALUMINIJSKE OKOMITE ŠIPKE ST65
65 mm



ALUMINIJSKE OKOMITE ŠIPKE ST110
110 mm

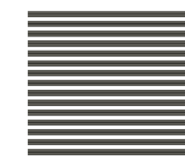

ALUMINIJSKE POPREČNE GREDE Q32
32 mm



ALUMINIJSKE POPREČNE GREDE Q65
65 mm

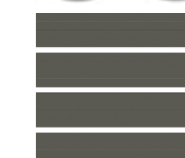

ALUMINIJSKE POPREČNE GREDE Q110
110 mm

KRILNA VRATA - Ispuna od čeličnog lima



Krilna vrata 2-2
Poprečne grede 100, antracit boja



Krilna vrata 1-1
Glatki lim s perforiranom trakom, zelena boja



Krilna vrata 1-2 (visina 2 m)
Glatki lim, srebrna boja



Krilna vrata 2-2
Perforirani lim, srebrna boja



Krilna vrata 1-2
Glatki lim s perforiranom trakom, zelena boja

KRILNA VRATA - Ispuna od aluminija



Krilna vrata 1-2
Aluminijske poprečne grede 110 mm, antracit boja



Krilna vrata 1-1
Aluminijske okomite šipke 32 mm, srebrna boja



Krilna vrata 2-2
Aluminijske poprečne grede 32 mm, antracit boja



Krilna vrata
Aluminijske okomite šipke 32 mm, antracit boja



OSOBNI PROLAZI

- Okvir od visokokvalitetnih aluminijskih profila
- Vrata se jednostavno prilagođavaju zahvaljujući podesivim šarkama.
- Masivni temeljni i ulazni stup od aluminijskog profila 150 x 150 mm

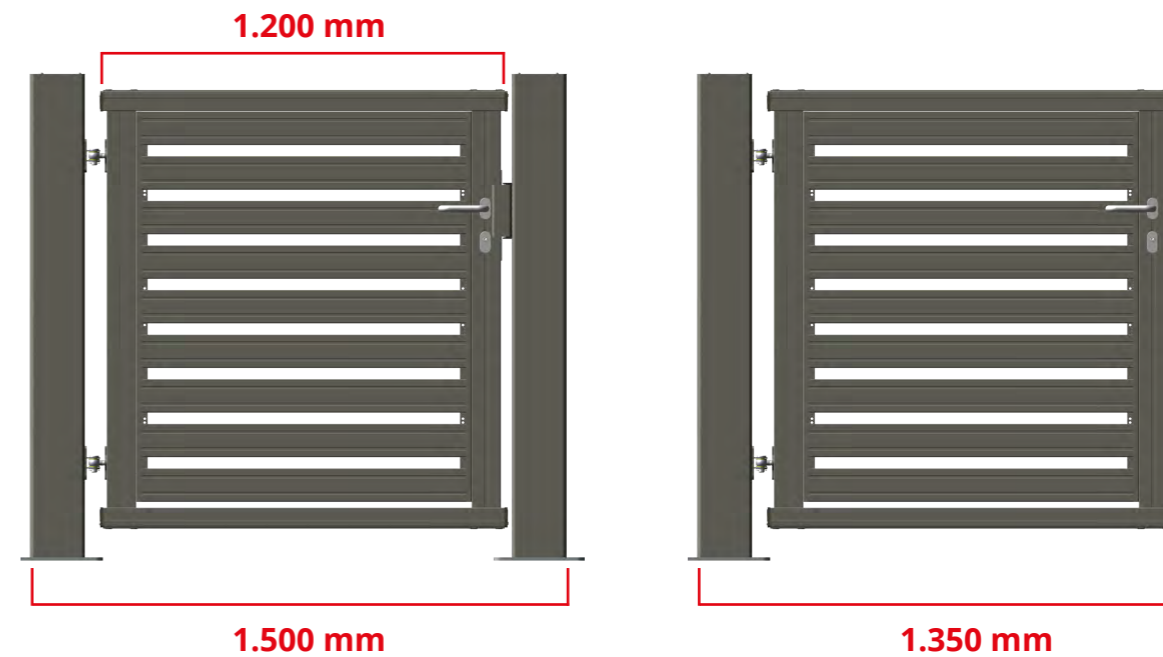

Želite li čitav dan otvarati vrata bez ključa ili pritiskom na gumb?

Dodajte osobnom prolazu sustav E-otvaranja (podizač), koji omogućuje otvaranja vrata pomoću portafona, čitača otisaka prstiju, gumba na vratima.

Visine: 1.000 mm
1.200 mm
1.400 mm
1.600 mm
1.800 mm
2.000 mm
uračunato je 100 mm razmaka od tla

Ispuna - lim



LIM GB
Valoviti lim

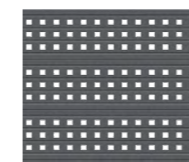

PERFORIRANI LIM LB
Valoviti lim s kvadratnom perforacijom 20 mm

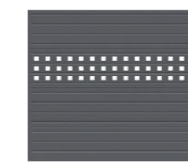

LIM S PERFORIRANOM TRAKOM GB+LB
Valoviti lim s trakom kvadratne perforacije 20 mm



POPREČNE GREDE Q100
100 mm



POPREČNE GREDE Q150
150 mm



POPREČNE GREDE Q200
200 mm

Ispuna - aluminij



ALUMINIJSKE OKOMITE ŠIPKE ST32
32 mm



ALUMINIJSKE OKOMITE ŠIPKE ST65
65 mm



ALUMINIJSKE OKOMITE ŠIPKE ST110
110 mm

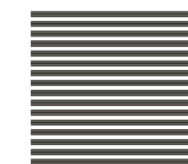

ALUMINIJSKE POPREČNE GREDE Q32
32 mm



ALUMINIJSKE POPREČNE GREDE Q65
65 mm

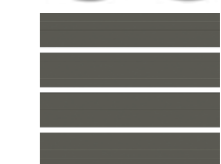

ALUMINIJSKE POPREČNE GREDE Q110
110 mm

OSOBNI PROLAZI - Ispune od čeličnog lima



Osobni prolaz
Glatki lim s perforiranom trakom, antracit boja



Osobni prolaz
Lim, srebrna boja



Osobni prolaz
Poprečne grede 200 mm, antracit boja

OSOBNI PROLAZI - Ispuna od aluminija



Osobni prolaz
Aluminijske poprečne grede 65 mm, antracit boja



Osobni prolaz
Aluminijske poprečne grede 110 mm, antracit boja



Osobni prolaz
Aluminijske okomite šipke 32 mm, zelena boja



Osobni prolaz
Perforirani lim, srebrna boja



Priključni osobni prolaz
Glatki lim s perforiranom trakom, srebrna boja



Osobni prolaz
Aluminijske poprečne grede 32 mm, antracit boja

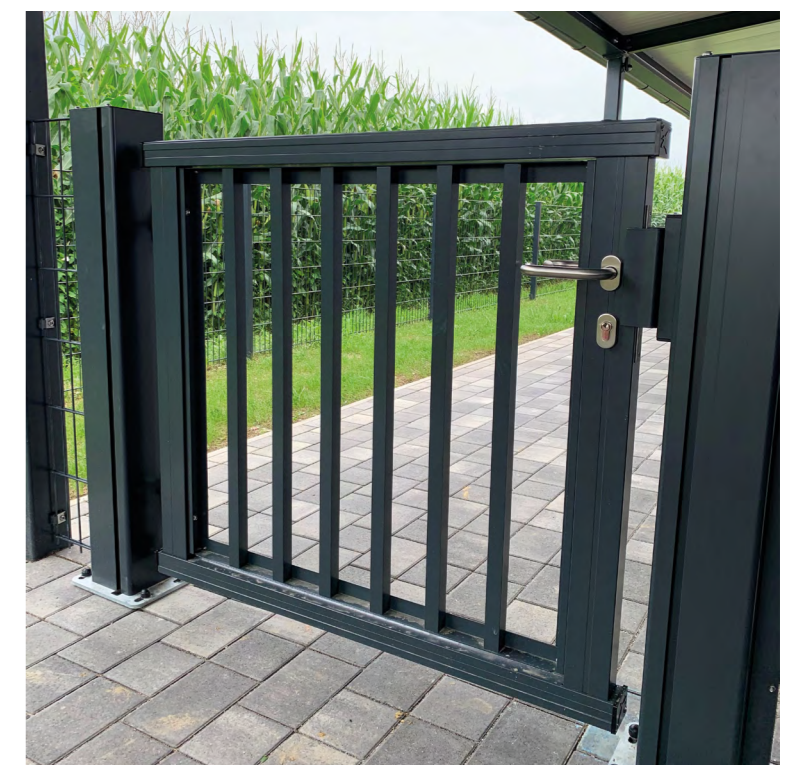

Osobni prolaz
Aluminijske okomite šipke 32 mm, antracit boja



Ogradni paneli - lim



Visine:
1.015 mm
1.215 mm
1.415 mm
1.615 mm
1.815 mm
2.015 mm

Širina
2.510 mm
(elementi se režu po mjeri na mjestu montaže)



LIM GB
Rebrasti lim



LIM S PERFORIRANOM TRAKOM GB+LB
Valoviti lim s trakom kvadratne perforacije 20 mm



PERFORIRANI LIM LB
Rebrasti lim s kvadratnom perforacijom 20 mm

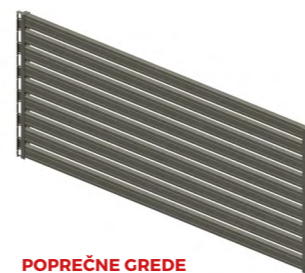

POPREČNE GREDE Q100
100 mm

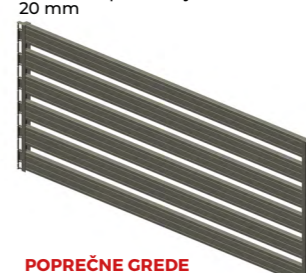

POPREČNE GREDE Q150
150 mm

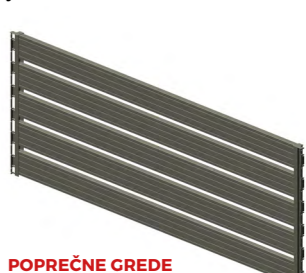

POPREČNE GREDE Q200
200 mm

Visine mm	Poprečne grede 100		Poprečne grede 150		Poprečne grede 200	
	Broj greda	Razmak	Broj greda	Razmak	Broj greda	Razmak
815 mm	6	25,5 mm	4	52,1 mm	3	85,5 mm
1.015 mm	7	35,5 mm	5	48 mm	4	52,2 mm
1.215 mm	9	23 mm	6	45,5 mm	5	35,5 mm
1.415 mm	10	29,9 mm	7	43,8 mm	6	25,5 mm
1.615 mm	11	35,5 mm	8	42,6 mm	6	65,5 mm
1.815 mm	13	27,1 mm	9	41,8 mm	7	52,2 mm
2.015 mm	14	31,6 mm	10	41,4 mm	8	42,6 mm

STUPOVI



Stup s pločom



- Visina: 1700 i 2.100 mm
- Ogradni stup od pocinčanog željeza 60 x 40 x 1.700 mm (D x Š x V), praškasto obojan (do 1.700 mm)
- Sa zavarenom pločom za pričvršćivanje s četiri vijka, praškasto obojana
- Debljina ploče za pričvršćivanje je 8 mm, dimenzije su 70 x 140 mm.

Stup za betoniranje



- Visina: 1500 mm, 2000 mm, 2200 mm, 2400 mm, 2800 mm
- Ogradni stup od pocinčanog željeznog profila 60 x 40 mm, praškasto obojan

Pokrivna letva

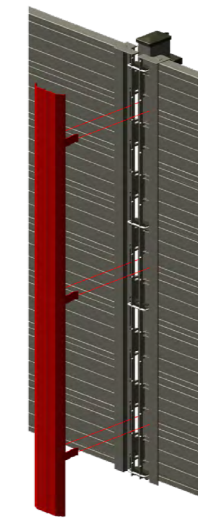

- Aluminijska letva za ljepši izgled
- Pričvršćivanje bez vijaka

OGRADNI PANELI - ŠIRINA 2.510 mm

- Površina je zaštićena premazom u boji visoke kvalitete u tri različite nijanse, što osigurava jednostavno održavanje i dugotrajnu otpornost na ogrebotine i vremenske utjecaje.
- Metalni paneli za privatnost, koji štite od neželjenih pogleda, široki su 2510 mm i prikladni za ograde na terasama ili balkonima.
- Stupovi se zasebno prodaju.

Nosivi kotač

Stup Ø50

Stup 60x40



Ravna greda

Stup Ø50

Stup 60x40



Obostrani nosač

Stup Ø50

Stup 60x40





OGRADNI PANELI - ŠIRINA 2.000 mm

- Odaberite čeličnu ili aluminijsku ploču
- Površina je zaštićena premazom u boji visoke kvalitete u tri različite nijanse, što osigurava jednostavno održavanje i dugotrajnu otpornost na ogrebotine i vremenske utjecaje.
- Metalne ploče prikladne za ograde na terasama ili balkonima.
- Stupovi se zasebno prodaju.

Ogradni paneli - lim



Visine:
1.015 mm
1.215 mm
1.415 mm
1.615 mm
1.815 mm
2.015 mm

Širina
2.000 mm
(elementi se režu po mjeri na mjestu montaže)

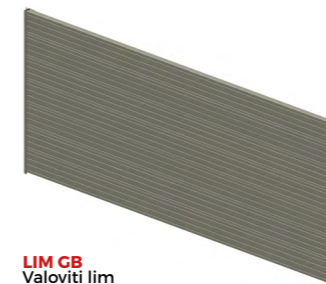

LIM CB
Valoviti lim



LIM S PERFORIRANOM TRAKOM GB+LB
Valoviti lim s trakom kvadratne perforacije 20 mm



PERFORIRANI LIM LB
Rebrasti lim s kvadratnom perforacijom 20 mm



POPREČNE GREDE Q100
100 mm



POPREČNE GREDE Q150
150 mm

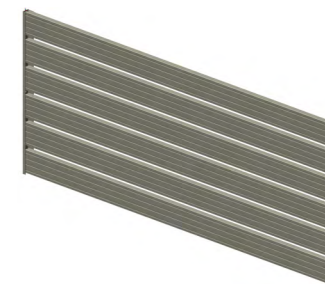

POPREČNE GREDE Q200
200 mm

Visine mm	Poprečne grede 100		Poprečne grede 150		Poprečne grede 200	
	Broj greda	Razmak	Broj greda	Razmak	Broj greda	Razmak
815 mm	6	25,5 mm	4	52,1 mm	3	85,5 mm
1.015 mm	7	35,5 mm	5	48 mm	4	52,2 mm
1.215 mm	9	23 mm	6	45,5 mm	5	35,5 mm
1.415 mm	10	29,9 mm	7	43,8 mm	6	25,5 mm
1.615 mm	11	35,5 mm	8	42,6 mm	6	65,5 mm
1.815 mm	13	27,1 mm	9	41,8 mm	7	52,2 mm
2.015 mm	14	31,6 mm	10	41,4 mm	8	42,6 mm

Aluminijske okomite šipke



Visine:
1.000 mm
1.200 mm
1.400 mm

Širina
2.000 mm
(elementi se režu po mjeri na mjestu montaže)



ALUMINIJSKE OKomite šipke ST32
32 mm
Razmak cca. 95 mm



ALUMINIJSKE OKomite šipke ST65
65 mm
Razmak cca. 40 mm



ALUMINIJSKE OKomite šipke ST110
110 mm
Razmak cca. 40 mm

Aluminijske poprečne grede

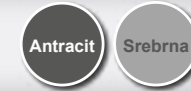

Visine:
1.000 mm
1.200 mm
1.400 mm

Širina
2.000 mm
(elementi se režu po mjeri na mjestu montaže)

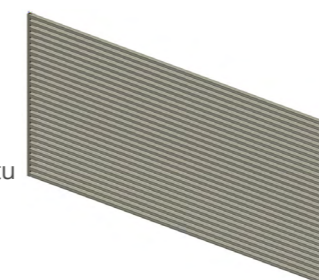

ALUMINIJSKE POPREČNE GREDE Q32
32 mm
Razmak cca. 20 do 30 mm

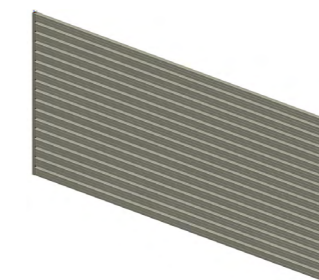

ALUMINIJSKE POPREČNE GREDE Q65
65 mm
Razmak cca. 20 do 30 mm

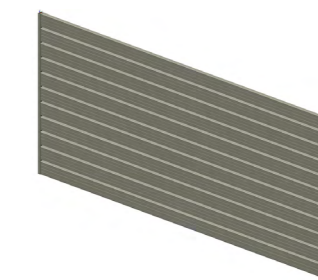

ALUMINIJSKE POPREČNE GREDE Q110
110 mm
Razmak cca. 20 do 30 mm

STUPOVI



Stup s pločom

- Visina: 1700 mm
- Ogradni stup od pocinčanog željeza 60 x 40 x 1.700 mm (D x Š x V), praškasto obojan
- Sa zavarenom pločom za pričvršćivanje s četiri vijka, praškasto obojana
- Debljina ploče za pričvršćivanje je 8 mm, dimenzije su 70 x 140 mm.
- Ogradni stup do 2.100 mm visine (opcionarno)



Stup za betoniranje

- Visina: 1500 mm, 2000 mm, 2200 mm, 2400 mm, 2800 mm
- Ogradni stup od pocinčanog željeznog profila 60 x 40 mm, praškasto obojan



Priključna greda

- U-profil 25/35/25/2, praškasto obojan
- univerzalno iskoristiv za vrste stupova
- jednostavna montaža kroz otvore na stupu ili zidu

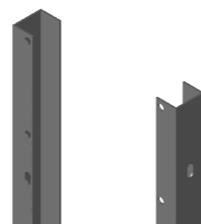

NAČINI MONTAŽE

Primjer montaže

- Brza montaža - priložene jednostavne upute
- Otvori i kanali za vijke su pripremljeni.
- Prikladne stupove potrebno je zasebno kupiti

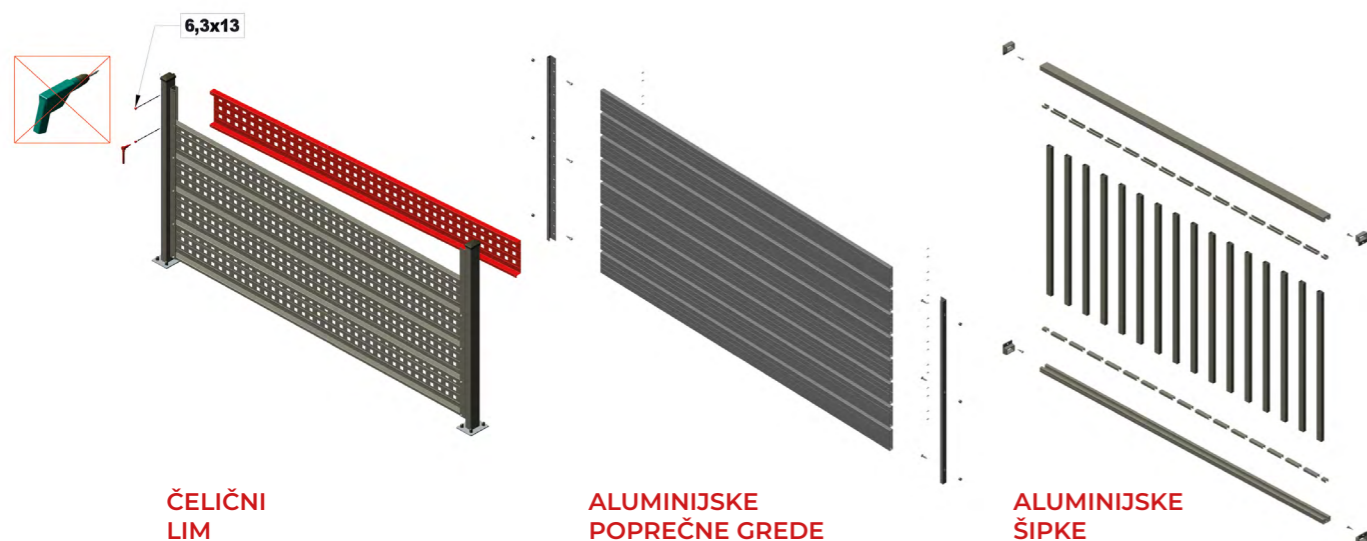

Ogradni panel - 2.510 mm



Za više privatnosti
Glatki lim s perforiranom trakom, antracit boja



Za više privatnosti
Glatki lim, antracit boja



Za više privatnosti
Perforirani lim, antracit boja



Poprečne grede
Poprečne grede 100 mm, srebrna boja

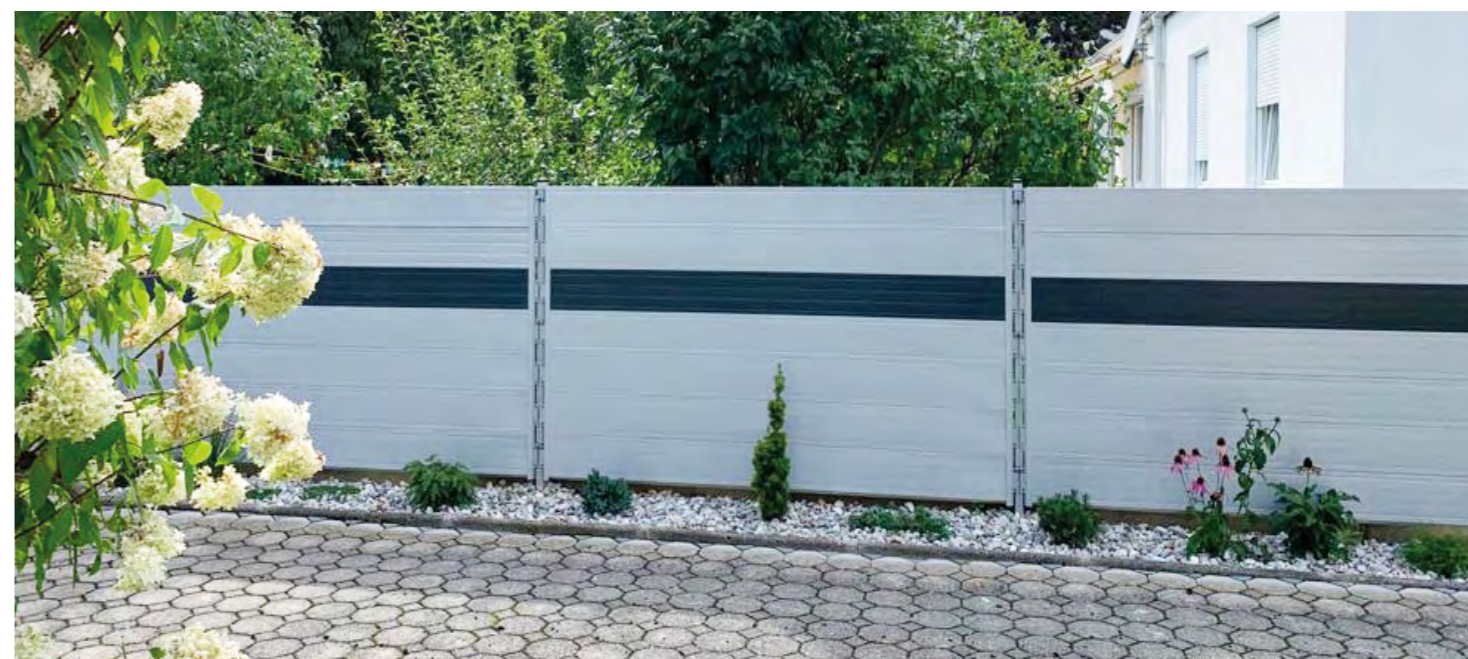

Za više privatnosti
Glatki lim s perforiranom trakom, antracit i srebrna boja

Ogradni panel - 2.000 mm



Za veću privatnost
Glatki lim s perforiranom trakom, antracit boja



Za veću privatnost
Glatki lim, srebrna boja



Za veću privatnost
Perforirani lim, antracit boja



Poprečne grede
Poprečne grede 100 mm, srebrna boja



Ograda za više privatnosti, dvobojna
Glatki lim s perforiranom trakom, antracit i srebrna boja

Aluminijske ograde



Alu ograda
Aluminijske okomite šipke 65 mm, srebrna i antracit boja



Aluminijska ograda
Aluminijske okomite šipke 32 mm, zelena boja



Aluminijska ograda
Aluminijske poprečne grede 65 mm, srebrna i antracit boja



Aluminijska ograda
Aluminijske poprečne grede 110 mm, antracit boja

